

Chapter 11: Computerized Treatment Planning Systems for External Photon Beam Radiotherapy

Set of 117 slides based on the chapter authored by
M.D.C. Evans

of the IAEA publication:

*Review of Radiation Oncology Physics:
A Handbook for Teachers and Students*

Objective:

To familiarize the student with the general principles, particular procedures and quality assurance of computerized treatment planning systems including hardware and software.



Slide set prepared in 2006
by G.H. Hartmann (Heidelberg, DKFZ)
Comments to S. Vatnitsky:
dosimetry@iaea.org

CHAPTER 11. TABLE OF CONTENTS

- 11.1 Introduction
- 11.2 System Hardware
- 11.3 System Software and Calculations Algorithms
- 11.4 Commissioning and Quality Assurance
- 11.5 Special Considerations



11.1 INTRODUCTION

- ❑ **Radiation treatment planning** represents a major part of the overall treatment process.
- ❑ It consists of many steps including patient diagnostic, tumor staging, image acquisition for treatment planning, the localization of tumor and healthy tissue volumes, optimal beam placement, and treatment simulation and optimization.
- ❑ A schematic overview also showing the associated quality assurance activities is given on the next slide.



Review of Radiation Oncology Physics: A Handbook for Teachers and Students - 11.1 Slide 1

11.1 INTRODUCTION

Steps of the treatment planning process, the professionals involved in each step and the QA activities associated with these steps (IAEA TRS 430)

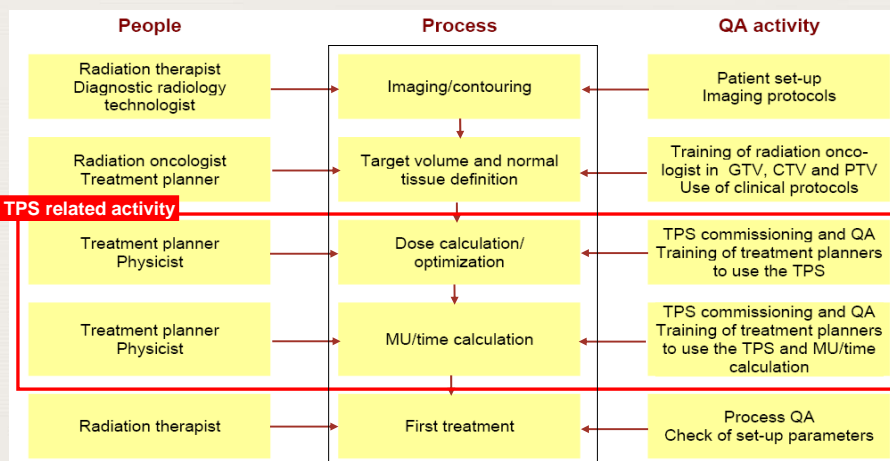

Review of Radiation Oncology Physics: A Handbook for Teachers and Students - 11.1 Slide 2

11.1 INTRODUCTION

- ❑ This chapter deals explicitly with that component of the treatment planning process that makes use of the computer.
- ❑ **Computerized Treatment Planning Systems** (TPS) are used in external beam radiation therapy to generate beam shapes and dose distributions with the intent to maximize tumor control and minimize normal tissue complications.



Review of Radiation Oncology Physics: A Handbook for Teachers and Students - 11.1 Slide 3

11.1 INTRODUCTION

- ❑ Treatment planning prior to the 1970s was generally carried out through the manual manipulation of standard isodose charts onto patient body contours that were generated by direct tracing or lead-wire representation, and relied heavily on the judicious choice of beam weight and wedging by an experienced dosimetrist.



Review of Radiation Oncology Physics: A Handbook for Teachers and Students - 11.1 Slide 4

11.1 INTRODUCTION

- ❑ The simultaneous development of computerized tomography, along with the advent of readily accessible computing power from the 1970s on, lead to the development of CT-based computerized treatment planning, providing the ability to view **dose distributions directly superimposed upon patient's axial anatomy.**

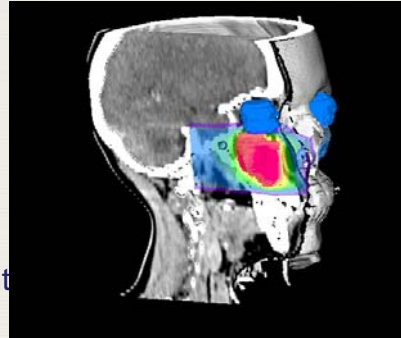

Review of Radiation Oncology Physics: A Handbook for Teachers and Students - 11.1 Slide 4

11.1 INTRODUCTION

- ❑ Advanced TPS are now able to represent patient anatomy, tumor targets and even dose distributions as three dimensional models.

Clinical target volume, both lungs, and spinal chord, as seen from behind (ICRU 50).

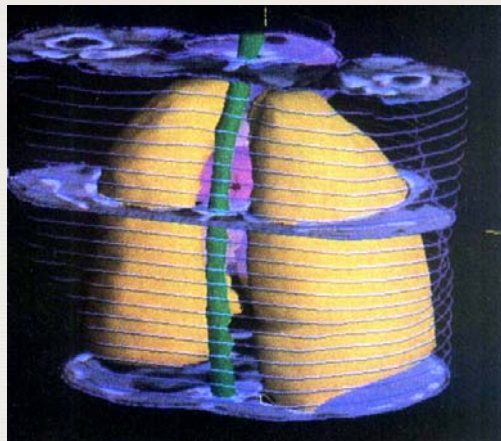

Review of Radiation Oncology Physics: A Handbook for Teachers and Students - 11.1 Slide 5

11.1 INTRODUCTION

- ❑ **Successive improvements** in treatment planning hardware and software have been most notable in the graphics, calculation and optimization aspects of current systems.

- ❑ Systems encompassing the “virtual patient” are able to display:
Beams-Eye Views (BEV)
of the patient's anatomy

Digitally Reconstructed
Radiographs (DRR)

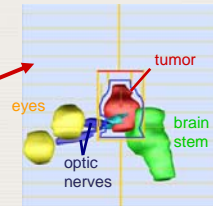
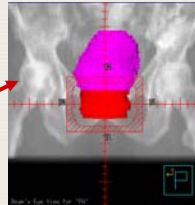

Review of Radiation Oncology Physics: A Handbook for Teachers and Students - 11.1 Slide 6

11.1 INTRODUCTION

- ❑ Dose calculations have evolved from simple 2D models through 3D models to 3D Monte-Carlo techniques, and increased computing power continues to increase the calculation speed.

Monte Carlo simulation of an
electron beam produced in
the accelerator head



Review of Radiation Oncology Physics: A Handbook for Teachers and Students - 11.1 Slide 7

11.1 INTRODUCTION

- ❑ Computerized treatment planning is a rapidly evolving modality, relying heavily on both hardware and software.
- ❑ As such it is necessary for related professionals to develop a workable Quality Assurance (QA) program that reflects the use of the TP system in the clinic, and is sufficiently broad in scope to ensure proper treatment delivery.



Review of Radiation Oncology Physics: A Handbook for Teachers and Students - 11.1 Slide 8

11.2 SYSTEM HARDWARE

- ❑ In the 1970s and 1980s treatment planning computers became readily available to individual radiation therapy centers.
- ❑ As **computer hardware technology** evolved and became more compact so did Treatment Planning Systems (TPS).
- ❑ Principal hardware components are described in the following slides.



Review of Radiation Oncology Physics: A Handbook for Teachers and Students - 11.2 Slide 1

11.2 SYSTEM HARDWARE

11.2.1 Treatment planning system hardware

Principal hardware components of a Treatment Planning (TP) system:

- (1) Central Processing Unit (CPU)
- (2) Graphics display
- (3) Memory
- (4) Digitizing devices
- (5) Output devices
- (6) Archiving and network communication devices



Review of Radiation Oncology Physics: A Handbook for Teachers and Students - 11.2.1 Slide 1

11.2 SYSTEM HARDWARE

11.2.1 Treatment planning system hardware

Principal hardware components of a TP system:

(1) Central Processing Unit

- The Central Processing Unit must have
 - **sufficient memory**
 - **sufficient high processor speed**as required by the operating system and the treatment planning software to run the software efficiently.
- Therefore, in the purchase phase the **specifications** for the system speed, Random Access Memory (RAM) and free memory, as well as networking capabilities must be carefully considered.



Review of Radiation Oncology Physics: A Handbook for Teachers and Students - 11.2.1 Slide 2

11.2 SYSTEM HARDWARE

11.2.1 Treatment planning system hardware

Principal hardware components of a TP system:

(2) Graphics display

- The graphics display be capable of rapidly displaying high resolution images.
- Graphics speed can be enhanced with video cards and hardware drivers (graphics processor).
- The resolution is sub-millimeter or better so as not to distort the input.
- The graphics display should be sufficient for accommodating the patient transverse anatomy on a 1:1 scale, typically 17 to 21 inches (43 to 53 cm) or larger.



Review of Radiation Oncology Physics: A Handbook for Teachers and Students - 11.2.1 Slide 3

11.2 SYSTEM HARDWARE

11.2.1 Treatment planning system hardware

Principal hardware components of a TP system:

(2) Graphics display



Review of Radiation Oncology Physics: A Handbook for Teachers and Students - 11.2.1 Slide 4

11.2 SYSTEM HARDWARE

11.2.1 Treatment planning system hardware

Principal hardware components of a TP system:

(3) Memory

- Memory and archiving functions are carried through
 - a) removable media:**
 - re-writable hard-disks
 - optical disks
 - DVDs
 - DAT tape
- Attention: these devices have been reported to suffer from long term instability.



IAEA

Review of Radiation Oncology Physics: A Handbook for Teachers and Students - 11.2.1 Slide 5

11.2 SYSTEM HARDWARE

11.2.1 Treatment planning system hardware

Principal hardware components of a TP system:

(3) Memory

- Memory and archiving functions are carried out through
 - b) network on:**
 - a remote computer
 - a server
 - the linac with its record-and-verify system
- Archiving operations may be carried out automatically during low use periods of the day.



IAEA

Review of Radiation Oncology Physics: A Handbook for Teachers and Students - 11.2.1 Slide 6

11.2 SYSTEM HARDWARE

11.2.1 Treatment planning system hardware

Principal hardware components of a TP system:

(4) Digitizing devices

- ❑ Digitizing devices are used to acquire manually entered patient data such as transverse contours and beams-eye-views of irregular field shapes.
- ❑ Methods:
 - Backlit tablets with stylus for manually tracing shapes
 - Scanners to digitize images from hardcopy such as paper or radiographic film
 - Video frame grabbers



Review of Radiation Oncology Physics: A Handbook for Teachers and Students - 11.2.1 Slide 7

11.2 SYSTEM HARDWARE

11.2.1 Treatment planning system hardware

Principal hardware components of a TP system:

(4) Digitizing devices



Review of Radiation Oncology Physics: A Handbook for Teachers and Students - 11.2.1 Slide 8

11.2 SYSTEM HARDWARE

11.2.1 Treatment planning system hardware

Principal hardware components of a TP system:

(5) Output devices

- Output devices include color laser printers and plotters for text and graphics.
- Printers and plotters can be networked for shared access.
- Hardcopy can be to paper or to film via a laser camera.
- Uninterruptible Power Supplies (UPS)



Review of Radiation Oncology Physics: A Handbook for Teachers and Students - 11.2.1 Slide 9

11.2 SYSTEM HARDWARE

11.2.1 Treatment planning system hardware

Principal hardware components of a TP system:

(5) Output devices (cont.)

- Uninterruptible Power Supplies (UPS) are recommended for the CPU, data servers, and other critical devices such as those used for storage and archiving.
- UPSs can provide back-up power so that a proper shut-down of the computer can be accomplished during power failures from the regular power distribution grid, and they also act as surge suppressors for the power.



Review of Radiation Oncology Physics: A Handbook for Teachers and Students - 11.2.1 Slide 10

11.2 SYSTEM HARDWARE

11.2.1 Treatment planning system hardware

Principal hardware components of a TP system: (6) Communications hardware

- ❑ Communications hardware includes modem or ethernet cards on the local workstations and multiple hubs for linking various peripheral devices and workstations. Large networks require fast switches running at least 100 Mb/s for file transfer associated with images.
- ❑ Physical connections on both small and large networks are run through coaxial cable, twisted pair or optical fiber depending upon speed requirements.



Review of Radiation Oncology Physics: A Handbook for Teachers and Students - 11.2.1 Slide 11

11.2 SYSTEM HARDWARE

11.2.2 Treatment planning system configurations

TP hardware systems can be classified into

- ❑ **Smaller TP system configurations for only a few users**
 - stand-alone lay-out and archiving
 - one central CPU for most functions and communication requests
 - requiring network switches to communicate with digital imaging devices such as CT-scanners

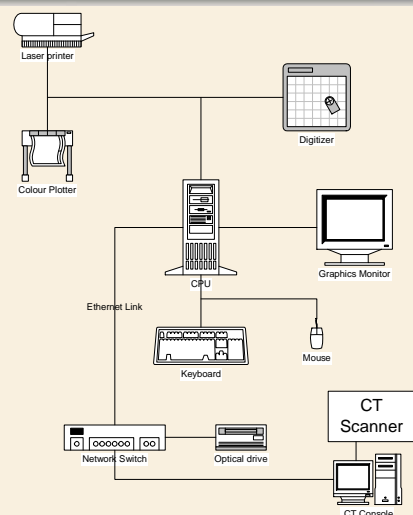

Review of Radiation Oncology Physics: A Handbook for Teachers and Students - 11.2.2 Slide 12

11.2 SYSTEM HARDWARE

11.2.2 Treatment planning system configurations

TP hardware systems can be classified into

❑ **Larger TP system configurations for many users**

- often operate on remote workstations within a hospital network
- may make use of Internet-based communication systems
- may require the services of an administrator to maintain security, user rights, networking back-up and archiving

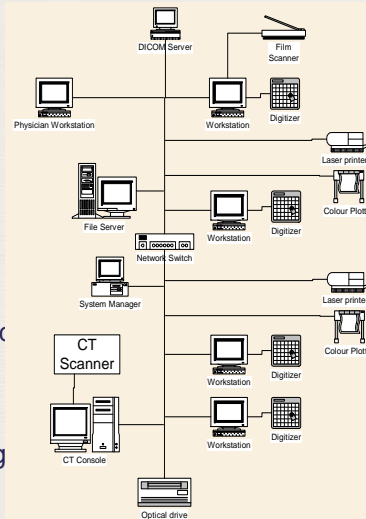

Review of Radiation Oncology Physics: A Handbook for Teachers and Students - 11.2.2 Slide 13

11.3 SYSTEM SOFTWARE AND CALCULATION ALGORITHMS

❑ The **software** of a TP system includes **components** for:

- The computer operating system (plus drivers, etc.)
- Utilities to enter treatment units and associated dose data
- Utilities to handle patient data files
- Contouring structures such as anatomical structures, target volumes, etc.
- Dose calculation
- TP evaluation
- Hardcopy devices
- Archiving
- Backup to protect operating system and application programs



Review of Radiation Oncology Physics: A Handbook for Teachers and Students - 11.3 Slide 1

11.3 SYSTEM SOFTWARE AND CALCULATION ALGORITHMS

11.3.1 Calculation algorithms

- ❑ Whereas the software modules to handle digital images, contours, beams, dose distributions, etc. are mostly very similar, the **dose algorithm** is the **most unique, critical and complex piece of the TP software**:
 - These modules are responsible for the correct representation of dose in the patient.
 - Results of dose calculations are frequently linked to beam-time or monitor unit (MU) calculations.
 - Many clinical decisions are taken on the basis of the calculated dose distributions.



Review of Radiation Oncology Physics: A Handbook for Teachers and Students - 11.3.1 Slide 1

11.3 SYSTEM SOFTWARE AND CALCULATION ALGORITHMS

11.3.1 Calculation algorithms

- ❑ It must be emphasized that prior to understanding sophisticated computerized treatment planning algorithms, **a proper understanding of manual dose calculations is essential.**
- ❑ For more details of manual dose calculations see Chapter 7!



Review of Radiation Oncology Physics: A Handbook for Teachers and Students - 11.3.1 Slide 2

11.3 SYSTEM SOFTWARE AND CALCULATION ALGORITHMS

11.3.1 Calculation algorithms

Beam model

- ❑ Because absorbed dose distributions cannot be measured directly in a patient, **they must be calculated.**
- ❑ The formalism for the mathematical manipulation of dosimetric data is sometimes referred to as **beam model.**
- ❑ The following slides are providing an overview of the development of beam models as required when calculation methods have evolved from simple 2 D calculations to 3D calculations.
- ❑ The ICRU Report 42 is giving examples for that.



Review of Radiation Oncology Physics: A Handbook for Teachers and Students - 11.3.1 Slide 3

11.3 SYSTEM SOFTWARE AND CALCULATION ALGORITHMS

11.3.1 Calculation algorithms

Early methods

- ❑ First beam models simply consist of a 2D-matrix of numbers representing the dose distribution in a plane.
- ❑ Cartesian coordinates are the most straightforward used coordinate system.

An isodose chart for a 10x10 cm beam of ^{60}Co radiation superimposed on a Cartesian grid of points.

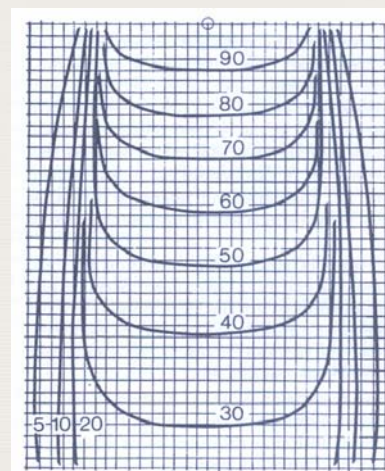

Review of Radiation Oncology Physics: A Handbook for Teachers and Students - 11.3.1 Slide 4

11.3 SYSTEM SOFTWARE AND CALCULATION ALGORITHMS

11.3.1 Calculation algorithms

- ❑ The disadvantages of matrix representation (in the early days of computers!) are the large amount of data and the number of different tables of data required.
- ❑ To reduce the number of data, **beam generating functions** have been introduced.
- ❑ The dose distribution in the central plane $D(x,z)$ was usually expressed by the product of two generating functions:

$$D(x,z) = P(z,z_{\text{ref}}) \cdot g_z(x)$$

$P(z,z_{\text{ref}})$ = depth dose along central axis relative to the dose at z_{ref}

$g_z(x)$ = off axis ratio at depth z



Review of Radiation Oncology Physics: A Handbook for Teachers and Students - 11.3.1 Slide 5

11.3 SYSTEM SOFTWARE AND CALCULATION ALGORITHMS

11.3.1 Calculation algorithms

- ❑ Example for $P(z,z_{\text{max}})$ introduced by van der Geijn as a quite precise generating function:

$$P(z, SSD, A) = 100 \cdot \left(\frac{SSD + z_{\text{max}}}{SSD + z} \right)^2 \cdot e^{-\mu(c)(z - z_{\text{max}})}$$

with $c \cdot c = A$ field size at center

$$\mu(c) = \mu_0 - a[1 - \exp(-bc)]$$



Review of Radiation Oncology Physics: A Handbook for Teachers and Students - 11.3.1 Slide 6

11.3 SYSTEM SOFTWARE AND CALCULATION ALGORITHMS

11.3.1 Calculation algorithms

- Example for $g(x)$ introduced by Sterling:

$$g(x) = 1 - \frac{1}{\sqrt{2\pi}\sigma} \int_{-\infty}^{x/X} \exp\left[-\frac{(\xi-1)^2}{2\sigma^2}\right] d\xi$$

with $\xi = x/X$

the off axis distance x expressed
as a fraction of the half geometrical
beam width X

σ

an empirical quantity



Review of Radiation Oncology Physics: A Handbook for Teachers and Students - 11.3.1 Slide 7

11.3 SYSTEM SOFTWARE AND CALCULATION ALGORITHMS

11.3.1 Calculation algorithms

- There are many other formulas available for the generating function for the depth dose along the central ray.
- There are also many dosimetric quantities used for this purpose such as:
 - **PDD = percentage depth dose**
 - **TAR = tissue air ratio**
 - **TPR = tissue phantom ratio**
 - **TMR = tissue maximum ratio**
- For more details please see Chapter 6



Review of Radiation Oncology Physics: A Handbook for Teachers and Students - 11.3.1 Slide 8

11.3 SYSTEM SOFTWARE AND CALCULATION ALGORITHMS

11.3.1 Calculation algorithms

- The approach to use two generating functions for the 2D dose distribution in the central plane:

$$D(x, z) = P(z, z_{\text{ref}}) \cdot g_z(x)$$

can be easily extended to three dimensions:

$$D(x, z) = P(z, z_{\text{ref}}) \cdot g_z(x, y)$$

- It was again van der Geijn, who introduced the factorization:

$$g_z(x, y) = g_{1,z}(x) \cdot g_{2,z}(y)$$



Review of Radiation Oncology Physics: A Handbook for Teachers and Students - 11.3.1 Slide 9

11.3 SYSTEM SOFTWARE AND CALCULATION ALGORITHMS

11.3.1 Calculation algorithms

- Another approach is the separation of the dose into its two components and to describe them differently:

$$D = D_{\text{prim}} + D_{\text{scat}}$$

- **primary radiation** D_{prim}
It is taken to be the radiation incident on the surface and includes photons coming directly from the source as well as radiation scattered from structures near the source and the collimator system.
- **scattered radiation** D_{scat}
It results from interactions of the primary radiation with the phantom (patient)

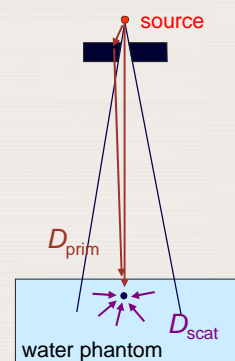

Review of Radiation Oncology Physics: A Handbook for Teachers and Students - 11.3.1 Slide 10

11.3 SYSTEM SOFTWARE AND CALCULATION ALGORITHMS

11.3.1 Calculation algorithms

- Johns and Cunningham based the separation of primary and scattered radiation dose on a separation of the tissue air ratio TAR :

$$TAR(z, r) = TAR_0(z, r = 0) + SAR(z, r)$$

$TAR_0(z, r = 0)$ is the TAR at depth z for a field of zero area (= primary radiation)

$SAR(z, r)$ is the term representing the scattered radiation in a circular beam with radius r



Review of Radiation Oncology Physics: A Handbook for Teachers and Students - 11.3.1 Slide 11

11.3 SYSTEM SOFTWARE AND CALCULATION ALGORITHMS

11.3.1 Calculation algorithms

- Accordingly, the dose D at a point x, y, z is given by:

$$D(x, y, z) = D_a \cdot \left[TAR_0(z) \cdot f(x, y) + \sum_i SAR(z, r_i) \frac{\Delta\theta_i}{2\pi} \right]$$

D_a is the dose in water, free in air at the central axis in depth z

$f(x, y)$ is analog to the position factor $g(x, y)$, however free in air

The summation is over sectors of circular beams (**Clarkson Method**).



Review of Radiation Oncology Physics: A Handbook for Teachers and Students - 11.3.1 Slide 12

11.3 SYSTEM SOFTWARE AND CALCULATION ALGORITHMS

11.3.1 Calculation algorithms

Beams-Eye View of a rectangular field

Calculation of radiation scattered to various points using the **Clarkson Method**:

O: at the beam axis

P: off axis within the beam

Q: outside the beam

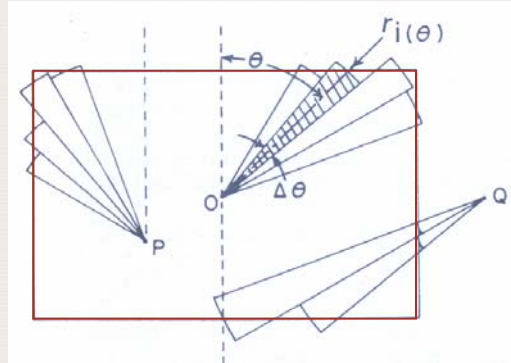

Review of Radiation Oncology Physics: A Handbook for Teachers and Students - 11.3.1 Slide 13

11.3 SYSTEM SOFTWARE AND CALCULATION ALGORITHMS

11.3.1 Calculation algorithms

- The method of decomposition a radiation into a primary and a scattered component is also used in current beam calculation algorithms.
- The **convolution–superposition method** is a model for that.
- With this method the **description of primary photon interactions** (↓) is separated from the transport of energy via scattered photons and charged particles produced through the photoelectric effect, Compton scattering and pair production.

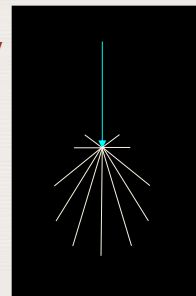

Review of Radiation Oncology Physics: A Handbook for Teachers and Students - 11.3.1 Slide 14

11.3 SYSTEM SOFTWARE AND CALCULATION ALGORITHMS

11.3.1 Calculation algorithms

- ❑ Scatter components may come from regions in the form of a slab, pencil beam, or a point.
- ❑ The pattern of spread of energy from such entities are frequently called "**scatter kernels**".

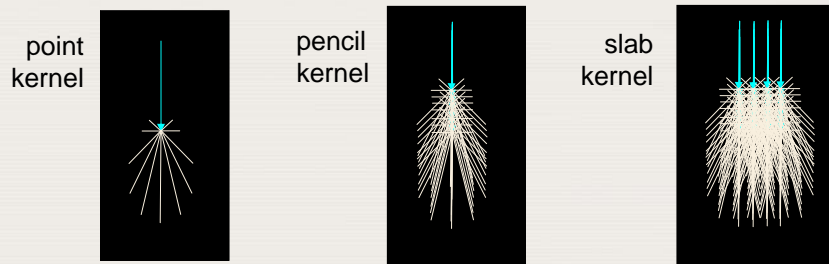

Review of Radiation Oncology Physics: A Handbook for Teachers and Students - 11.3.1 Slide 15

11.3 SYSTEM SOFTWARE AND CALCULATION ALGORITHMS

11.3.1 Calculation algorithms

- ❑ In this manner, **changes in scattering** due to changes in the beam shape, beam intensity, patient geometry and tissue inhomogeneities can be incorporated more easily into the dose distribution.
- ❑ Pencil beam algorithms are common for electron beam dose calculations. In these techniques the energy spread or dose kernel at a point is summed along a line in phantom to obtain a pencil-type beam or dose distribution.
- ❑ By integrating the pencil beam over the patient's surface to account for the changes in primary intensity and by modifying the shape of the pencil beam with depth and tissue density, a dose distribution can be generated.



Review of Radiation Oncology Physics: A Handbook for Teachers and Students - 11.3.1 Slide 16

11.3 SYSTEM SOFTWARE AND CALCULATION ALGORITHMS

11.3.1 Calculation algorithms

- Monte Carlo or random sampling techniques are another currently applied calculation method used to generate dose distributions.
- Results are obtained by following the histories of a large number of particles **as they emerge from the source of radiation** and undergo multiple scattering interactions both inside and outside the patient.

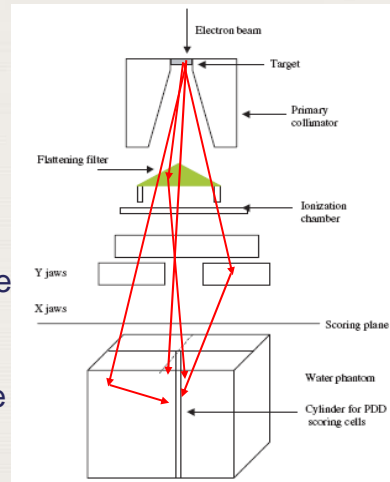

Review of Radiation Oncology Physics: A Handbook for Teachers and Students - 11.3.1 Slide 17

11.3 SYSTEM SOFTWARE AND CALCULATION ALGORITHMS

11.3.1 Calculation algorithms

- Monte Carlo techniques are able to accurately model the physics of particle interactions by accounting for the geometry of individual linear accelerators, beam shaping devices such as blocks and multileaf collimators (MLCs), and patient surface and density irregularities.
- Monte Carlo techniques for computing dose spread arrays or kernels used in convolution–superposition methods are described by numerous authors, including Mackie, and in the review chapters in Khan and Potish.



Review of Radiation Oncology Physics: A Handbook for Teachers and Students - 11.3.1 Slide 18

11.3 SYSTEM SOFTWARE AND CALCULATION ALGORITHMS

11.3.1 Calculation algorithms

- ❑ Although Monte Carlo techniques require a large number of particle histories to achieve statistically acceptable results, they are now becoming more and more practical for routine treatment planning.
- ❑ A detailed summary of treatment planning algorithms in general is in particular provided in :
The Modern Technology for Radiation Oncology:
A Compendium for Medical Physicists and Radiation Oncologist (editor Van Dyk)



Review of Radiation Oncology Physics: A Handbook for Teachers and Students - 11.3.1 Slide 19

11.3 SYSTEM SOFTWARE AND CALCULATION ALGORITHMS

11.3.2 Beam modifiers

- ❑ Treatment planning software for photon beams and electron beams must be capable of handling the many diverse **beam modifying devices** found on linac models.
- ❑ **Photon beam modifiers:**
 - jaws
 - blocks
 - compensators
 - MLCs
 - wedges
- ❑ **Electron beam modifiers**
 - cones
 - blocks
 - bolus



Review of Radiation Oncology Physics: A Handbook for Teachers and Students - 11.3.2 Slide 1

11.3 SYSTEM SOFTWARE AND CALCULATION ALGORITHMS

11.3.2 Beam modifiers: Photon beam modifiers

Jaws

- ❑ The field size is defined by motorized collimating jaws.
- ❑ Jaws can move independently or in pairs and are usually located as an upper and lower set.
- ❑ Jaws may over-travel the central axis of the field by varying amounts.
- ❑ The travel motion will determine the junction produced by two abutting fields.
- ❑ The TPS should account for the penumbra and differences in radial and transverse open beam symmetry.

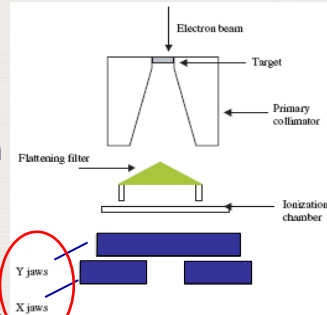

Review of Radiation Oncology Physics: A Handbook for Teachers and Students - 11.3.2 Slide 2

11.3 SYSTEM SOFTWARE AND CALCULATION ALGORITHMS

11.3.2 Beam modifiers: Photon beam modifiers

Blocks

- ❑ Blocks are used for individual field shielding.
- ❑ The TPS must take into account the effective attenuation of the block.
- ❑ The dose through a partially shielded calculation volume, or voxel, is calculated as a partial sum of the attenuation proportional to the region of the voxel shielded.
- ❑ TPSs are able to generate files for blocked fields that can be exported to commercial block cutting machines.



Review of Radiation Oncology Physics: A Handbook for Teachers and Students - 11.3.2 Slide 3

11.3 SYSTEM SOFTWARE AND CALCULATION ALGORITHMS

11.3.2 Beam modifiers: Photon beam modifiers

Multi-leaf collimator

- ❑ An MLC is a beam shaping device that can place almost all conventional mounted blocks, with the exception of island blocking and excessively curved field shapes.
- ❑ MLCs with a leaf width of the order of 0.5–1.0 cm at the isocenter are typical; MLCs providing smaller leaf widths are referred to as micro MLCs.



Review of Radiation Oncology Physics: A Handbook for Teachers and Students - 11.3.2 Slide 4

11.3 SYSTEM SOFTWARE AND CALCULATION ALGORITHMS

11.3.2 Beam modifiers: Photon beam modifiers

Multi-leaf collimator

- ❑ The MLC may be able to cover all or part of the entire field opening, and the leaf design may be incorporated into the TPS to model transmission and penumbra.

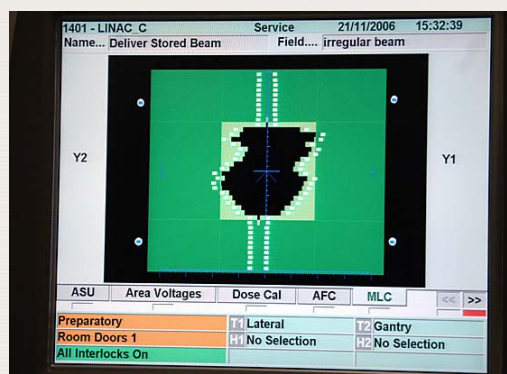

Review of Radiation Oncology Physics: A Handbook for Teachers and Students - 11.3.2 Slide 5

11.3 SYSTEM SOFTWARE AND CALCULATION ALGORITHMS

11.3.2 Beam modifiers: Photon beam modifiers

Static Wedges

- ❑ Static wedges remain the principal devices for modifying dose distributions.
- ❑ The TPS can model the effect of the dose both along and across the principal axes of the physical wedge, as well as account for any PDD change due to beam hardening and/or softening along the central axis ray line.
- ❑ The clinical use of wedges may be limited to field sizes smaller than the maximum collimator setting.

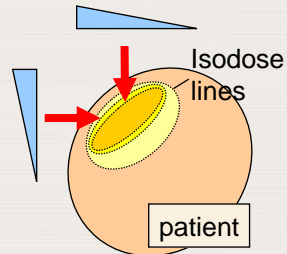

Review of Radiation Oncology Physics: A Handbook for Teachers and Students - 11.3.2 Slide 6

11.3 SYSTEM SOFTWARE AND CALCULATION ALGORITHMS

11.3.2 Beam modifiers: Photon beam modifiers

Dynamic Wedges

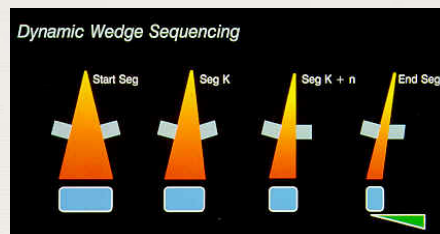

- ❑ More recently, wedging may be accomplished by the use of universal or sliding wedges incorporated into the linac head, or, even more elegantly, by dynamic wedging accomplished by the motion of a single jaw while the beam is on.



Review of Radiation Oncology Physics: A Handbook for Teachers and Students - 11.3.2 Slide 7

11.3 SYSTEM SOFTWARE AND CALCULATION ALGORITHMS

11.3.2 Beam modifiers: Electron beam modifiers

Custom compensators

- ❑ Custom compensators may be designed by TPSs to account for missing tissue or to modify dose distributions to conform to irregular target shapes.
- ❑ TPSs are able to generate files for compensators that can be read by commercial compensator cutting machines.



Review of Radiation Oncology Physics: A Handbook for Teachers and Students - 11.3.2 Slide 8

11.3 SYSTEM SOFTWARE AND CALCULATION ALGORITHMS

11.3.2 Beam modifiers: Electron beam modifiers

Cones or applicators

- ❑ Electron beams are used with external collimating devices known as cones or applicators that reduce the spread of the electron beam in the air.
- ❑ The design of these cones is dependent on the manufacturer and affects the dosimetric properties of the beam.



Review of Radiation Oncology Physics: A Handbook for Teachers and Students - 11.3.2 Slide 9

11.3 SYSTEM SOFTWARE AND CALCULATION ALGORITHMS

11.3.2 Beam modifiers: Electron beam modifiers

Shielding for irregular fields

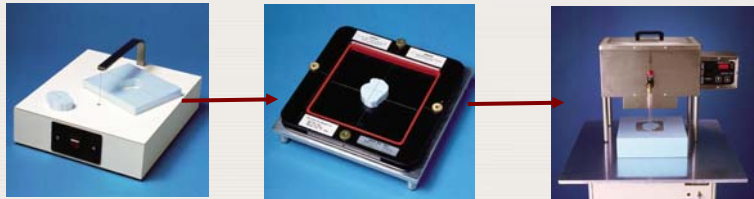

- ❑ Electron shielding for irregular fields may be accomplished with the use of thin lead or low melting point alloy inserts.
- ❑ Shielding inserts can have significant effects on the dosimetry that should be modeled by the TPS.



Review of Radiation Oncology Physics: A Handbook for Teachers and Students - 11.3.2 Slide 10

11.3 SYSTEM SOFTWARE AND CALCULATION ALGORITHMS

11.3.2 Beam modifiers: Electron beam modifiers

Scattering foil

- ❑ The design of the linac head may be important for electron dosimetry, especially for Monte Carlo type calculations.
- ❑ In these conditions particular attention is paid to the scattering foil.
- ❑ The effective or virtual SSD will appear to be shorter than the nominal SSD, and should be taken into consideration by the TPS.

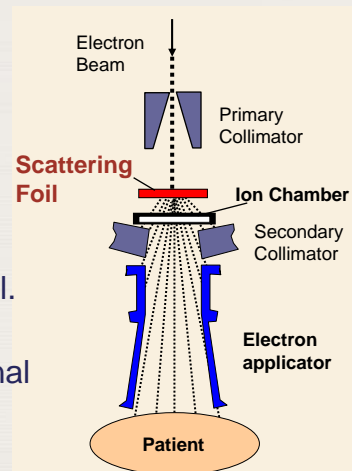

Review of Radiation Oncology Physics: A Handbook for Teachers and Students - 11.3.2 Slide 11

11.3 SYSTEM SOFTWARE AND CALCULATION ALGORITHMS

11.3.2 Beam modifiers: Electron beam modifiers

Bolus

- ❑ Bolus may be used to increase the surface dose for both photon and electron treatments.
- ❑ Bolus routines incorporated into TPS software will usually permit manual or automatic bolus insertion in a manner that does not modify the original patient CT data.
- ❑ It is important that the TPS can distinguish between the bolus and the patient so that bolus modifications and removal can be achieved with ease.

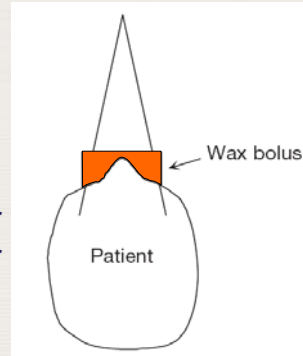

Review of Radiation Oncology Physics: A Handbook for Teachers and Students - 11.3.2 Slide 12

11.3 SYSTEM SOFTWARE AND CALCULATION ALGORITHMS

11.3.3 Heterogeneity corrections

- ❑ Heterogeneity or inhomogeneity corrections generally account for the differences between the standard beam geometry of a radiation field incident upon a large uniform water phantom and the beam geometry encountered by the beam incident upon the patient's surface.
- ❑ In particular, beam obliquity and regions where the beam does not intersect the patient's surface will affect the dose distribution.



Review of Radiation Oncology Physics: A Handbook for Teachers and Students - 11.3.3 Slide 1

11.3 SYSTEM SOFTWARE AND CALCULATION ALGORITHMS

11.3.3 Heterogeneity corrections

- ❑ Inside the patient, the **relative electron density** of the irradiated medium can be determined from the **patient CT data set**.

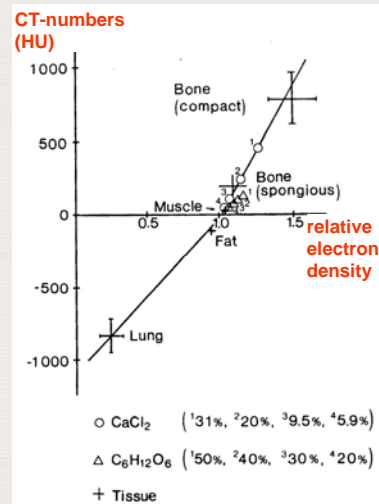

Review of Radiation Oncology Physics: A Handbook for Teachers and Students - 11.3.3 Slide 2

11.3 SYSTEM SOFTWARE AND CALCULATION ALGORITHMS

11.3.3 Heterogeneity corrections

- ❑ Most TPS algorithms apply either a correction factor approach or a model based approach.
- ❑ Fast methods: Generalized correction factors
 - **power law method**
 - **equivalent TAR method**
- ❑ Longer calculation times: Model based approaches
 - **differential SAR approach**
 - **Monte Carlo based algorithms consider**
- ❑ Most methods are still having difficulties with dose calculations at tissue interfaces.



Review of Radiation Oncology Physics: A Handbook for Teachers and Students - 11.3.3 Slide 3

11.3 SYSTEM SOFTWARE AND CALCULATION ALGORITHMS

11.3.4 Image display and dose volume histograms

**Beams
Eye View**



**Room
Eye View**

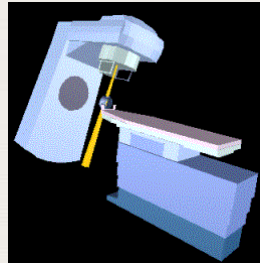

- ❑ BEVs and room eye views (REVs) are used by modern TPSs.
- ❑ The **BEV** is often used in conjunction with DRRs to aid in assessing tumor coverage and for beam shaping with blocks or an MLC.



Review of Radiation Oncology Physics: A Handbook for Teachers and Students - 11.3.4 Slide 1

11.3 SYSTEM SOFTWARE AND CALCULATION ALGORITHMS

11.3.4 Image display and dose volume histograms

without collision
between gantry
and table

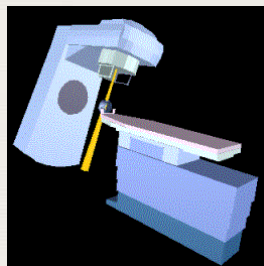

with collision
between gantry
and table

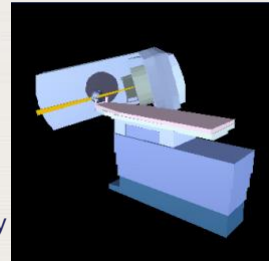

- ❑ **The Room Eye View** gives the user a perception of the relationship of the gantry and table to each other and may help in avoiding potential collisions when moving from the virtual plan to the actual patient set-up.



Review of Radiation Oncology Physics: A Handbook for Teachers and Students - 11.3.4 Slide 2

11.3 SYSTEM SOFTWARE AND CALCULATION ALGORITHMS

11.3.4 Image display and dose volume histograms

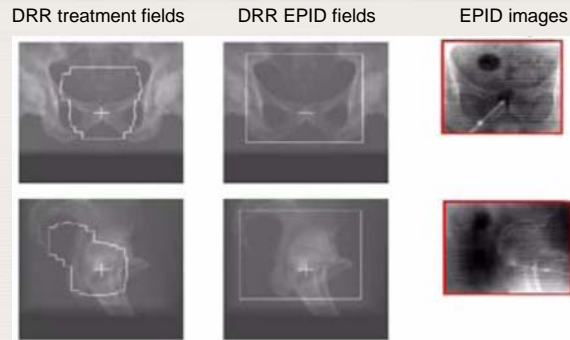

- ❑ **Portal image generation** can be accomplished by TPSs by substituting energy shifted attenuation coefficients for CT data sets. These virtual portal images with the treatment field superimposed can be used for comparison with the portal images obtained with the patient in the treatment position on the treatment machine.



Review of Radiation Oncology Physics: A Handbook for Teachers and Students - 11.3.4 Slide 3

11.3 SYSTEM SOFTWARE AND CALCULATION ALGORITHMS

11.3.4 Image display and dose volume histograms

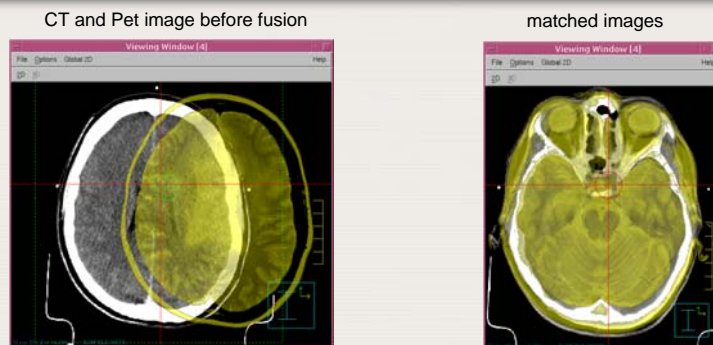

- ❑ **Image registration** routines can help match simulator, MR, positron emission tomography (PET), single photon emission computed tomography (SPECT), ultrasound and other image sources to planning CT and treatment acquired portal images.



Review of Radiation Oncology Physics: A Handbook for Teachers and Students - 11.3.4 Slide 4

11.3 SYSTEM SOFTWARE AND CALCULATION ALGORITHMS

11.3.4 Image display and dose volume histograms

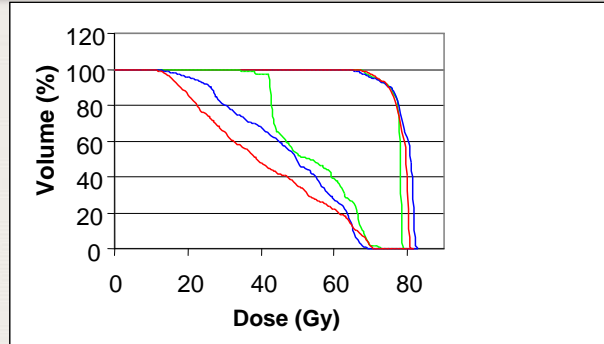

- ❑ DVHs are calculated by the TPS with respect to the target and critical structure volumes in order to establish the adequacy of a particular treatment plan and to compare competing treatment plans.



Review of Radiation Oncology Physics: A Handbook for Teachers and Students - 11.3.4 Slide 5

11.3 SYSTEM SOFTWARE AND CALCULATION ALGORITHMS

11.3.4 Image display and dose volume histograms

Two types of DVHs are in use:

- ❑ Direct (or differential) DVH →
- ❑ Cumulative (or integral) DVH →
Definition:
The volume that receives **at least** the given dose and plotted versus dose.

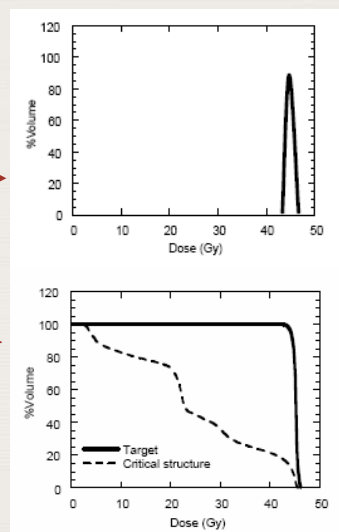

Review of Radiation Oncology Physics: A Handbook for Teachers and Students - 11.3.5 Slide 6

11.3 SYSTEM SOFTWARE AND CALCULATION ALGORITHMS

11.3.5 Optimization and monitor unit calculation

- ❑ The possibility of simulating radiation therapy with a computer and predicting the resulting dose distribution with high accuracy allows an optimization of the treatment.
- ❑ Optimization routines including inverse planning are provided by TPSs with varying degrees of complexity.
- ❑ Algorithms can modify beam weights and geometry or calculate beams with a modulated beam intensity to satisfy the user criteria.



11.3 SYSTEM SOFTWARE AND CALCULATION ALGORITHMS

11.3.5 Optimization and monitor unit calculation

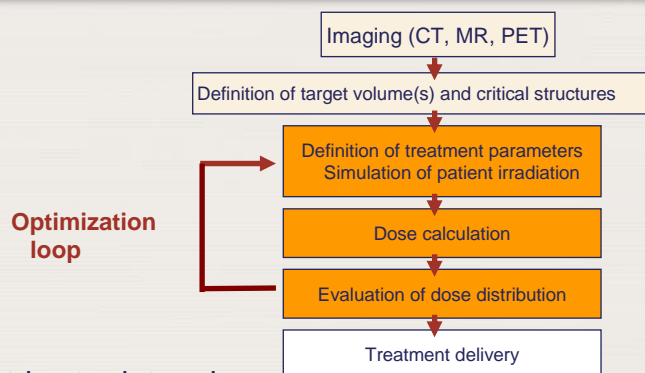

- ❑ Optimization tries to determine the parameters of the treatment in an iterative loop in such a way that the best possible treatment will be delivered for an individual patient.



11.3 SYSTEM SOFTWARE AND CALCULATION ALGORITHMS

11.3.5 Optimization and monitor unit calculation

- Beam time and MU calculation by TPSs is frequently **optional**.
- The associated calculation process is directly related to the normalization method.
- Required input data:
 - absolute output at a reference point
 - decay data for cobalt units
 - output factors
 - wedge factors
 - tray factors and other machine specific



Review of Radiation Oncology Physics: A Handbook for Teachers and Students - 11.3.5 Slide 3

11.3 SYSTEM SOFTWARE AND CALCULATION ALGORITHMS

11.3.6 Record and verify systems

- A computer-aided record-and-verify system aims to **compare** the set-up parameters with the prescribed values.
- Patient identification data, machine parameters and dose prescription data are entered into the computer **beforehand**.
- At the time of treatment, these parameters are identified at the treatment machine and, **if there is no difference**, the treatment can **start**.
- If discrepancies are present this is indicated and the parameters concerned are highlighted.**



Review of Radiation Oncology Physics: A Handbook for Teachers and Students - 11.3.6 Slide 1

11.3 SYSTEM SOFTWARE AND CALCULATION ALGORITHMS

11.3.6 Record and verify systems

- ❑ Networked TPSs allow for interface between linac record and verify systems, either through a direct connection or through a remote server using fast switches.
- ❑ Communication between the TPS and the linac avoids the errors associated with manual transcription of paper printouts to the linac and can help in the treatment of complex cases involving asymmetric jaws and custom MLC shaped fields.
- ❑ Record and verify systems may be provided by
 - the TPS manufacturer,
 - the linac manufacturer or
 - third party software.



Review of Radiation Oncology Physics: A Handbook for Teachers and Students - 11.3.6 Slide 2

11.3 SYSTEM SOFTWARE AND CALCULATION ALGORITHMS

11.3.7 Biological modeling

- ❑ Distributions modeled on biological effects may in the future become more clinically relevant than those based upon dose alone.
- ❑ Such distributions will aid in predicting both the tumor control probability (TCP) and the normal tissue complication probability (NTCP).

TCP and **NTCP** are usually illustrated by plotting two sigmoid curves, one for the TCP (curve A) and the other for NTCP (curve B).

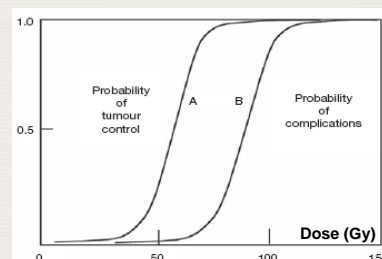

Review of Radiation Oncology Physics: A Handbook for Teachers and Students - 11.3.7 Slide 1

11.3 SYSTEM SOFTWARE AND CALCULATION ALGORITHMS

11.3.7 Biological modeling

- ❑ These algorithms can account for specific organ dose response and aid in assessing the dose fractionation and volume effects.
- ❑ Patient specific data can be incorporated in the biological model to help predict individual dose response to a proposed treatment regime.



Review of Radiation Oncology Physics: A Handbook for Teachers and Students - 11.3.7 Slide 2

11.4 DATA ACQUISITION AND ENTRY

- ❑ Data acquisition refer to all data to establish the:
 - **Machine model**
 - **Beam model**
 - **Patient model**



Review of Radiation Oncology Physics: A Handbook for Teachers and Students - 11.4 Slide 1

11.4 DATA ACQUISITION AND ENTRY

11.4.1 Machine data

- ❑ An important aspect of the configuration of a TPS is the creation of a machine database that contains descriptions of the treatment machines, i.e. **the machine model**.
- ❑ Each TPS requires the entry of a **particular set** of parameters, names and other information, which is used to create the geometrical and mechanical descriptions of the treatment machines for which treatment planning will be performed.
- ❑ It must be ensured that any machine, modality, energy or accessory that has **not been tested** and **accepted** be made **unusable** or otherwise made **inaccessible** to the routine clinical users of the system.



Review of Radiation Oncology Physics: A Handbook for Teachers and Students - 11.4.1 Slide 1

11.4 DATA ACQUISITION AND ENTRY

11.4.1 Machine data

- ❑ The following are examples of machine entry data:
 - **Identification** (code name) of machines, modalities, beams (energies) and accessories.
 - **Geometrical distances:** SAD, collimator, accessory, etc.
 - **Allowed mechanical movements and limitations:** upper & lower jaw limits, asymmetry, MLC, table, etc.
 - **Display co-ordinate system** gantry, collimator and table angles, table x, y, z position, etc.



Review of Radiation Oncology Physics: A Handbook for Teachers and Students - 11.4.1 Slide 2

11.4 DATA ACQUISITION AND ENTRY

11.4.1 Machine data

Caution

- ❑ Issues such as co-ordinates, names and device codes **require verification**, since any mislabelling or incorrect values could cause systematic misuse of all the plans generated within the TPS.
- ❑ In particular the **scaling conventions** for gantry, table and collimator rotation etc. **used in a particular institution** must be fully understood and described accurately.



Review of Radiation Oncology Physics: A Handbook for Teachers and Students - 11.4.1 Slide 3

11.4 DATA ACQUISITION AND ENTRY

11.4.2 Beam data acquisition and entry

- ❑ The requirements on the set of beam entry data may be different and depend on a specific TPS.
- ❑ They must be well understood.
- ❑ Data are mainly obtained by scanning in a water phantom.

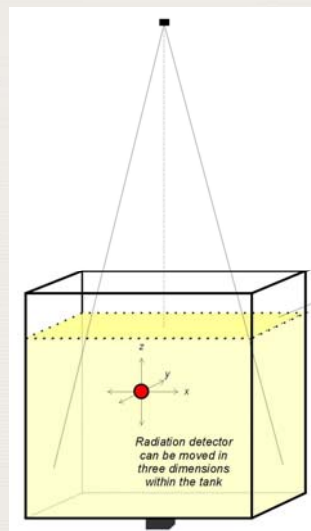

Review of Radiation Oncology Physics: A Handbook for Teachers and Students - 11.4.2 Slide 1

11.4 DATA ACQUISITION AND ENTRY

11.4.2 Beam data acquisition and entry

☐ Typical photon beam data sets include:

- **Central axis PDDs**
Off Axis Ratios (profiles)
Output factors } for a range of square fields
for open fields
for wedged fields
- **Diagonal field profiles**
to account for radial and transverse open beam
asymmetry;
(it may only be possible to acquire half-field scans,
depending upon the size of the water tank)



Review of Radiation Oncology Physics: A Handbook for Teachers and Students - 11.4.2 Slide 2

11.4 DATA ACQUISITION AND ENTRY

11.4.2 Beam data acquisition and entry

Caution

- ☐ Special consideration must be given to the geometry of the **radiation detector** (typically ionization chambers or diodes) and to any **correction factors** that must be applied to the data.
- ☐ Beam data are often smoothed and renormalized both following measurement and prior to data entry into the treatment planning computer.



Review of Radiation Oncology Physics: A Handbook for Teachers and Students - 11.4.1 Slide 3

11.4 DATA ACQUISITION AND ENTRY

11.4.2 Beam data acquisition and entry

- The penumbra may be fitted to, or extracted from, measured data. In either case it is important that scan lengths be of sufficient length, especially for profiles at large depths, where field divergence can become considerable.



Review of Radiation Oncology Physics: A Handbook for Teachers and Students - 11.4.2 Slide 4

11.4 DATA ACQUISITION AND ENTRY

11.4.2 Beam data acquisition and entry

- The calculation of dose at any point is usually directly linked to the dose under reference conditions (field size, reference depth and nominal SSD etc.).
- Particular care must therefore be taken with respect to the determination of absolute dose under reference conditions, as these will have a global effect on time and MU calculations.

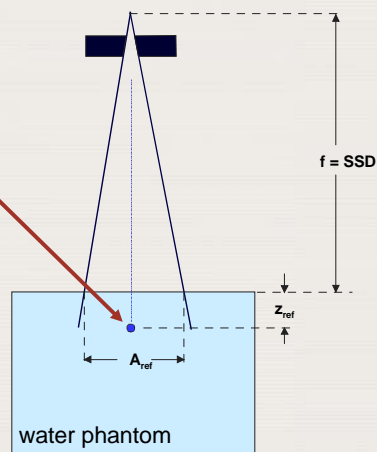

Review of Radiation Oncology Physics: A Handbook for Teachers and Students - 11.4.2 Slide 5

11.4 DATA ACQUISITION AND ENTRY

11.4.2 Beam data acquisition and entry

- Measured beam data relevant to the MLC can include:
 - transmission through the leaf
 - inter-leaf transmission between adjacent leaves
 - intra-leaf transmission occurring when leaves from opposite carriage banks meet end on



Review of Radiation Oncology Physics: A Handbook for Teachers and Students - 11.4.2 Slide 6

11.4 DATA ACQUISITION AND ENTRY

11.4.2 Beam data acquisition and entry

- Beam measurement for electrons is more difficult than for photons because of the continuously decreasing energy of the beam with depth.
- Electron beam data measured with ionization chambers must be first converted to dose with an appropriate method, typically using a look-up table of stopping power ratios. Measurements with silicon diodes are often considered to be tissue equivalent and give a reading directly proportional to dose.



Review of Radiation Oncology Physics: A Handbook for Teachers and Students - 11.4.2 Slide 7

11.4 DATA ACQUISITION AND ENTRY

11.4.2 Beam data acquisition and entry

- ❑ Beam data acquired can be entered:
 - **manually using a digitizer tablet and tracing stylus**
A hard copy of beam data is used, and it is important that both the beam data printout and the digitizer be routinely checked for calibration.
 - **via a keyboard**
Keyboard data entry is inherently prone to operator error and requires independent verification.
 - **via file transfer from the beam acquisition computer**
Careful attention must be paid to the file format. File headers contain formatting data concerning the direction of measurement, SSD, energy, field size, wedge type and orientation, detector type and other relevant parameters. Special attention must be paid to these labels to ensure that they are properly passed to the TPS.



Review of Radiation Oncology Physics: A Handbook for Teachers and Students - 11.4.2 Slide 8

11.4 DATA ACQUISITION AND ENTRY

11.4.3 Patient data

- ❑ The patients' anatomical information may be entered via the digitizer using one or more contours obtained manually or it may come from a series of transverse slices obtained via a CT scan.

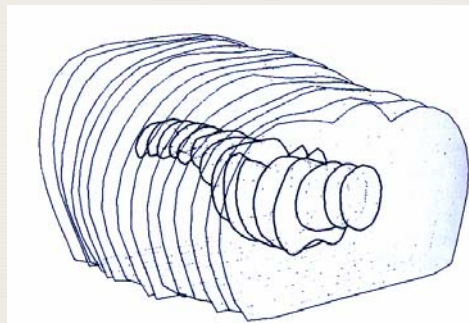

Review of Radiation Oncology Physics: A Handbook for Teachers and Students - 11.4.3 Slide 1

11.4 DATA ACQUISITION AND ENTRY

11.4.3 Patient data

- ❑ 3-D information data required to localize the tumor volume and normal tissues may be obtained from various imaging modalities such as:
 - multi-slice CT or MR scanning
 - image registration and fusion techniques in which the volume described in one data set (MRI, PET, SPECT, ultrasound, digital subtraction angiography (DSA) is translated or registered with another data set, typically CT.



Review of Radiation Oncology Physics: A Handbook for Teachers and Students - 11.4.3 Slide 2

11.4 DATA ACQUISITION AND ENTRY

11.4.3 Patient data

- ❑ The patient image data may be transferred to the TPS via DICOM formats (Digital Imaging and Communications in Medicine)
 - **DICOM 3** format
 - **DICOM RT** (radiotherapy) format
- ❑ Both formats were adopted by the American College of Radiology (ACR) and the National Electrical Manufacturers Association (NEMA) in 1993.



Review of Radiation Oncology Physics: A Handbook for Teachers and Students - 11.4.3 Slide 3

11.4 DATA ACQUISITION AND ENTRY

11.4.3 Patient data

- ❑ To ensure accurate dose calculation, the CT numbers must be converted to electron densities and scattering powers.
- ❑ The conversion of CT numbers to electron density and scattering power is usually performed with a user defined look-up table.

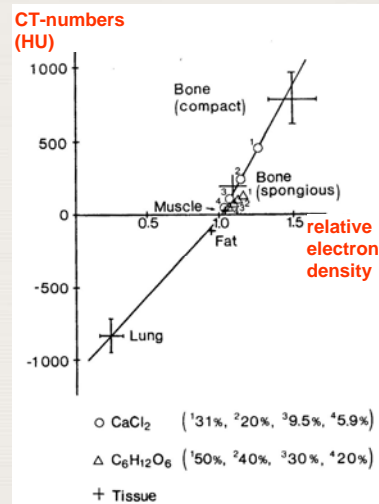

Review of Radiation Oncology Physics: A Handbook for Teachers and Students - 11.4.3 Slide 4

11.4 DATA ACQUISITION AND ENTRY

11.4.3 Patient data

- ❑ Such tables can be generated using a phantom containing various inserts of known densities simulating normal body tissues such as bone and lung.

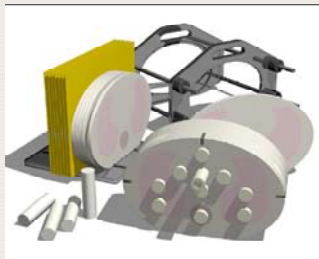

CIRS torso phantom

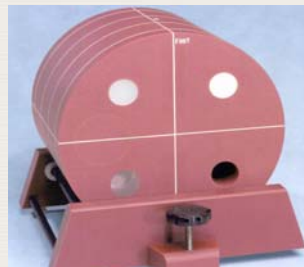

Gammex RMI CT test tool



Review of Radiation Oncology Physics: A Handbook for Teachers and Students - 11.4.3 Slide 5

11.4 DATA ACQUISITION AND ENTRY

11.4.3 Patient data

- ❑ The rendering of patient anatomy from the point of view of the radiation source (**BEV**) is useful in viewing the path of the beam, the structures included in the beam and the shape of the blocks or MLC defined fields.

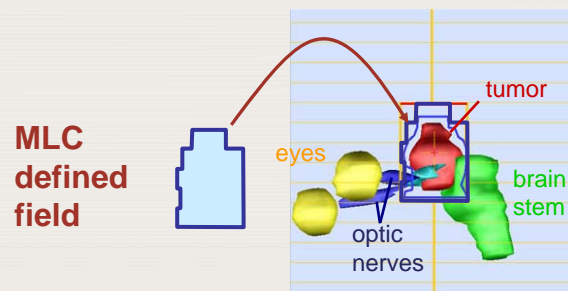

Review of Radiation Oncology Physics: A Handbook for Teachers and Students - 11.4.3 Slide 6

11.5 COMMISSIONING AND QUALITY ASSURANCE

- ❑ **Commissioning** is the process of preparing a specific equipment for clinical service.
- ❑ Commissioning is one of the most important parts of the entire QA program for both the TPS and the planning process.
- ❑ Commissioning involves testing of system functions, documentation of the different capabilities and verification of the ability of the dose calculation algorithms to reproduce measured dose calculations.



Review of Radiation Oncology Physics: A Handbook for Teachers and Students - 11.5 Slide 1

11.5 COMMISSIONING AND QUALITY ASSURANCE

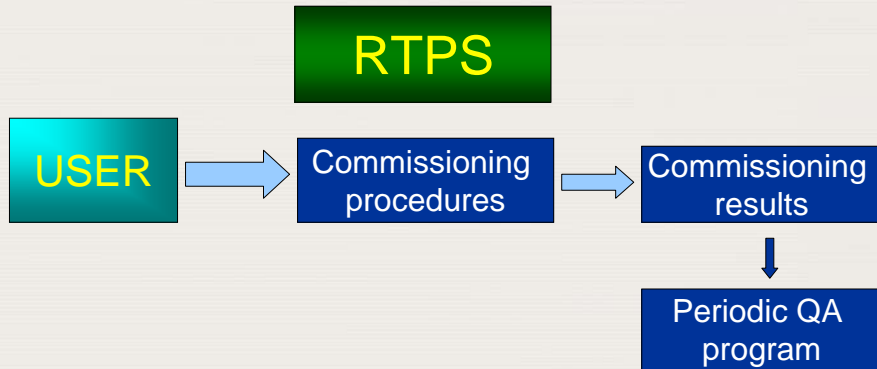

Review of Radiation Oncology Physics: A Handbook for Teachers and Students - 11.1 Slide 2

11.5 COMMISSIONING AND QUALITY ASSURANCE

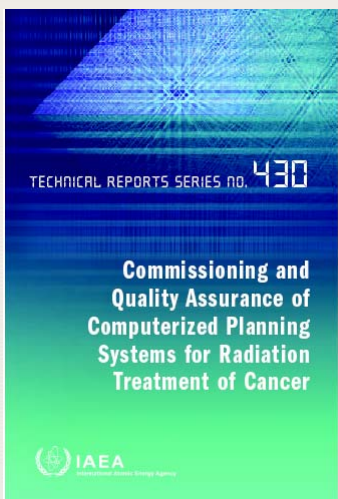

IAEA TRS 430 - the most complete reference work in the field of QA of RTPS

- provides a general framework on how to design a QA programme for all kinds of RTPS
- describes a large number of tests and procedures that should be considered and should in principle fulfil the needs for all RTPS users.



Review of Radiation Oncology Physics: A Handbook for Teachers and Students - 11.5 Slide 3

11.5 COMMISSIONING AND QUALITY ASSURANCE

11.5.1 Errors

Uncertainty:

- ❑ When reporting the result of a measurement, it is obligatory that some quantitative indication of the **quality of the result** be given. Otherwise the receiver of this information cannot really assess its reliability.
- ❑ The term "**Uncertainty**" has been introduced for that.
- ❑ **Uncertainty is a parameter** associated with the result of a measurement of a quantity that characterizes the dispersion of the values that could be reasonably be attributed to the quantity.



Review of Radiation Oncology Physics: A Handbook for Teachers and Students - 11.5.1 Slide 1

11.5 COMMISSIONING AND QUALITY ASSURANCE

11.5.1 Errors

Error:

- ❑ In contrast to uncertainty, an error is the deviation of a given quantity following an **incorrect procedure**.
- ❑ Errors can be made even if the result is within tolerance.
- ❑ However, the significance of the error will be dependent on the proximity of the result to tolerance.
- ❑ Sometimes the user knows that a systematic error exists but may not have control over the elimination of the error.
- ❑ This is typical for a TPS for which the dose calculation algorithm may have a reproducible deviation from the measured value at certain points within the beam.



Review of Radiation Oncology Physics: A Handbook for Teachers and Students - 11.5.1 Slide 2

11.5 COMMISSIONING AND QUALITY ASSURANCE

11.5.1 Errors

Tolerance Level:

- The term tolerance level is used to indicate that the result of a quantity has been measured with **acceptable accuracy**.
- Tolerances values should be set with the aim of achieving the **overall uncertainties desired**.
- However, if the **measurement uncertainty** is greater than the tolerance level set, then random variations in the measurement will lead to unnecessary intervention.
- Therefore, it is practical to set a tolerance level at the measurement uncertainty at the 95% confidence level.



Review of Radiation Oncology Physics: A Handbook for Teachers and Students - 11.5.1 Slide 3

11.5 COMMISSIONING AND QUALITY ASSURANCE

11.5.1 Errors

Action Level:

- A result outside the action level is **unacceptable** and **demands action**.
- It is useful to set action levels higher than tolerance levels thus providing flexibility in monitoring and adjustment.
- Action levels are often set at **approximately twice the tolerance level**
- However, some critical parameters may require tolerance and action levels to be set much closer to each other or even at the same value.



Review of Radiation Oncology Physics: A Handbook for Teachers and Students - 11.5.1 Slide 4

11.5 COMMISSIONING AND QUALITY ASSURANCE

11.5.1 Errors

Illustration of a possible relation between uncertainty, tolerance level and action level

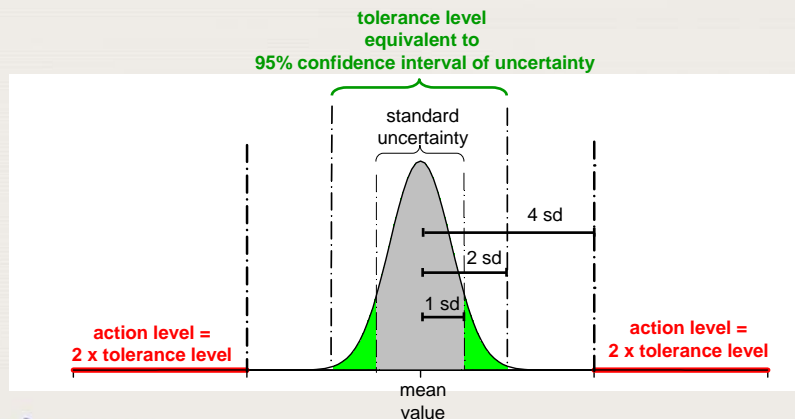

Review of Radiation Oncology Physics: A Handbook for Teachers and Students - 11.5.1 Slide 5

11.5 COMMISSIONING AND QUALITY ASSURANCE

11.5.1 Errors

The system of actions:

- If a measurement result is within the tolerance level, no action is required.
- If the measurement result exceeds the action level, immediate action is necessary and the equipment must not be clinically used until the problem is corrected.
- If the measurement falls between tolerance and action levels, this may be considered as currently acceptable. Inspection and repair can be performed later, for example after patient irradiations. If repeated measurements remain consistently between tolerance and action levels, adjustment is required.



Review of Radiation Oncology Physics: A Handbook for Teachers and Students - 11.5.1 Slide 6

11.5 COMMISSIONING AND QUALITY ASSURANCE

11.5.1 Errors

Typical tolerance levels from AAPM TG53 (examples)

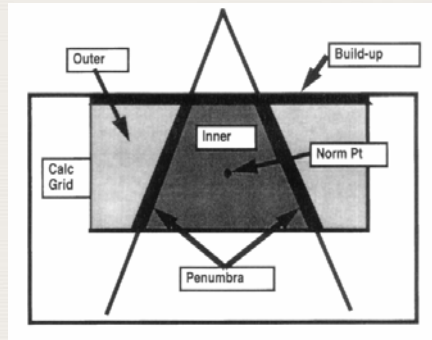

- Square field CAX: 1%
- MLC penumbra: 3%
- Wedge outer beam: 5%
- Buildup-region: 30%
- 3D inhomogeneity CAX: 5%

For analysis of agreement between calculations and measurements, the dose distribution due to a beam is broken up into several regions.



Review of Radiation Oncology Physics: A Handbook for Teachers and Students - 11.5.1 Slide 7

11.5 COMMISSIONING AND QUALITY ASSURANCE

11.5.2 Verification

- Data verification** entails a rigorous comparison between measured or input data and data produced by the TPS.
- Standard test data sets such as the AAPM TG 23 data set can be used to assess TPS performance.
- Detailed description of tests are provided by:
 - Fraas et al, "AAPM Radiation Therapy Committee **TG53**: Quality assurance program for radiotherapy treatment planning", Med Phys 25,1773-1836 (1998)
 - IAEA, "Commissioning and quality assurance of computerized planning systems for radiation treatment of cancer", **TRS 430**



Review of Radiation Oncology Physics: A Handbook for Teachers and Students - 11.5.2 Slide 1

11.5 COMMISSIONING AND QUALITY ASSURANCE

11.5.2 Verification

□ Typical issues of calculation and verification (TRS 430)

Comparison techniques

- 1-D Comparison of one or more depth dose and profile curves
Table of differences of depth dose curves for several field sizes
- 2-D Isodose line (IDL) comparison: plotted IDLs for calculated and measured data
Dose difference display: subtract the calculated dose distribution from the measured distribution; highlight regions of under- and overexposure, if available
Distance to agreement: plot the distance required for measured and calculated isodose lines to be in agreement, if available
- 3-D Generate a 3-D measured dose distribution by interpolation of 2-D coronal dose distributions and a depth dose curve, if available
DVH comparison of 3-D calculated and measured distributions, if available
DVH of 3-D dose difference distribution, if available



Review of Radiation Oncology Physics: A Handbook for Teachers and Students - 11.5.2 Slide 2

11.5 COMMISSIONING AND QUALITY ASSURANCE

11.5.2 Verification

□ Typical commissioning tests

Item	Test
Digitizer and plotter	Enter a known contour and compare it with final hard copy
Geometry	Oblique fields, fields using asymmetric jaws
Beam junction	Test cases measured with film or detector arrays
Rotational beams	Measured or published data
File compatibility between CT & TPS	May require separate test software for the transfer
Image transfer	Analysis of the input data for a known configuration and density (phantom) to detect any error in magnification and in spatial coordinates



Review of Radiation Oncology Physics: A Handbook for Teachers and Students - 11.5.2 Slide 3

11.5 COMMISSIONING AND QUALITY ASSURANCE

11.5.3 Spot checks

- Spot checks of measured data versus those obtained from the TPS are required; these spot checks can involve calculations of fields shielded by blocks or MLCs.
- Spot checks of static and dynamic wedged fields with respect to measured data points are also recommended.
- A detector array may be used to verify wedged and, even more importantly, dynamically wedged dose distributions produced by the TPS.
- Wedge distributions produced by the TPS must be verified for identification, orientation, beam hardening and field size limitations.



Review of Radiation Oncology Physics: A Handbook for Teachers and Students - 11.5.3 Slide 1

11.5 COMMISSIONING AND QUALITY ASSURANCE

11.5.4 Normalization and beam weighting

- Dose normalization and beam weighting options vary from one TPS to another and have a direct impact on the representation of patient dose distributions.
- Normalization methods refer to:
 - a specific point such as the **isocenter**
 - the **intersection** of several beam axes
 - a **minimum or maximum value** in a slice or entire volume
 - an arbitrary **isodose line** in a volume
 - a **minimum or maximum iso-surface**
 - a specific **point in a target or organ**



Review of Radiation Oncology Physics: A Handbook for Teachers and Students - 11.5.4 Slide 1

11.5 COMMISSIONING AND QUALITY ASSURANCE

11.5.4 Normalization and beam weighting

Beam weighting

Different approaches are possible:

- 1) Weighting of beams as to how much they contribute to the dose at the target
- 2) Weighting of beams as to how much dose is incident on the patient

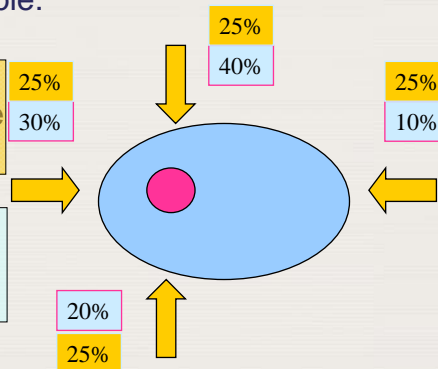

These are NOT the same



Review of Radiation Oncology Physics: A Handbook for Teachers and Students - 11.5.4 Slide 2

11.5 COMMISSIONING AND QUALITY ASSURANCE

11.5.4 Normalization and beam weighting

- Manual checks of beam time or monitor units must be well familiar with the type of normalization and beam weighting method of a specific TPS.
- Examples are given in more detail in Chapter 7.
- Since many treatment plans involve complex beam delivery, these manual checks do not need to be precise, yet they serve as a method of detecting gross errors on the part of the TPS.



Review of Radiation Oncology Physics: A Handbook for Teachers and Students - 11.5.4 Slide 2

11.5 COMMISSIONING AND QUALITY ASSURANCE

11.5.5 Dose volume histograms and optimization

- ❑ Current state of the art TPSs use DVHs to summarize the distribution of the dose to particular organs or other structures of interest.
- ❑ According to TRS 430, tests for DVHs must refer to:
 - Type (direct, cumulative and differential)
 - Plan normalization
 - Relative and absolute dose
 - Volume determination
 - Histogram dose bin size
 - Structures
 - Consistency
 - Calculation of grid size and points distribution
 - DVH comparison guidelines
 - Dose statistics



Review of Radiation Oncology Physics: A Handbook for Teachers and Students - 11.5.5 Slide 1

11.5 COMMISSIONING AND QUALITY ASSURANCE

11.5.5 Dose volume histograms and optimization

- ❑ Optimization routines are provided by many TPSs, and intensity modulated beams having complex dose distributions may be produced.
- ❑ As these set-ups involve partial or fully dynamic treatment delivery, spot checks of absolute dose to a point, as well as a verification of the spatial and temporal aspects of the dose distributions using either film or detector arrays, are a useful method of evaluating the TPS beam calculations.



Review of Radiation Oncology Physics: A Handbook for Teachers and Students - 11.5.5 Slide 2

11.5 COMMISSIONING AND QUALITY ASSURANCE

11.5.6 Training and documentation

- ❑ Training and a reasonable amount of documentation for both the hardware and software are essential. Typically the training is given on the site and at the manufacturer's facility. Ongoing refresher courses are available to familiarize dosimetrists and physicists with 'bug fixes' and system upgrades.
- ❑ Documentation regarding software improvements and fixes is kept for reference by users at the clinic. TPS manufacturers have lists of other users and resource personnel to refer to.



Review of Radiation Oncology Physics: A Handbook for Teachers and Students - 11.5.6 Slide 1

11.5 COMMISSIONING AND QUALITY ASSURANCE

11.5.6 Training and documentation

- ❑ Most manufacturers of TPSs organize users' meetings, either as standalone meetings or in conjunction with national or international scientific meetings of radiation oncologists or radiation oncology physicists. During these meetings special seminars are given by invited speakers and users describing the particular software systems, new developments in hardware and software as well as problems and solutions to specific software problems.



Review of Radiation Oncology Physics: A Handbook for Teachers and Students - 11.5.6 Slide 2

11.5 COMMISSIONING AND QUALITY ASSURANCE

11.5.7 Scheduled Quality Assurance

- ❑ Following acceptance and commissioning of a computerized TPS a scheduled quality assurance program must be established to verify the output of the TPS.
- ❑ Such a scheduled quality assurance program is frequently also referred to as "**Periodic Quality Assurance**".
- ❑ A recommended structure is given in: IAEA, "Commissioning and quality assurance of computerized planning systems for radiation treatment of cancer", **TRS 430**



Review of Radiation Oncology Physics: A Handbook for Teachers and Students - 11.5.7 Slide 1

11.5 COMMISSIONING AND QUALITY ASSURANCE

11.5.7 Scheduled Quality Assurance

Example of a periodic quality assurance program (TRS430)

	patient specific	weekly	monthly	quarterly	annually	after upgrade
Hardware		Digitizer	CPU Digitizer			CPU Digitizer
				Plotter		Plotter
				Backup		Backup
Anatomical information	CT transfer			CT image		CT transfer
	Anatomy					CT image
						Anatomy
External beam software	Beam				Beam	Beam
	MU check					
	Plan details		Plan details			
	Pl. transfer		Pl. transfer		Pl. transfer	Pl. transfer



Review of Radiation Oncology Physics: A Handbook for Teachers and Students - 11.6 Slide 2

11.5 COMMISSIONING AND QUALITY ASSURANCE

11.5.7 Scheduled Quality Assurance

- ❑ In addition, care must be given to in-house systems that are undocumented and undergo routine development.
- ❑ These TPSs may require quality assurance tests at a higher frequency.



Review of Radiation Oncology Physics: A Handbook for Teachers and Students - 11.5.7 Slide 3

11.5 COMMISSIONING AND QUALITY ASSURANCE

11.5.7 Scheduled Quality Assurance

- ❑ There is a common thread of continuity:

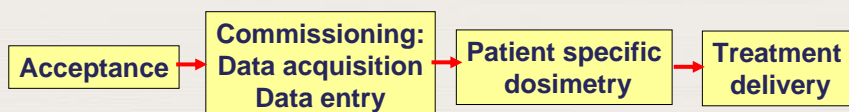

- ❑ The medical physicist must be able to link all these steps together, and a well planned and scheduled set of quality assurance tests for the TPS is an important link in the safe delivery of therapeutic radiation.



Review of Radiation Oncology Physics: A Handbook for Teachers and Students - 11.5.7 Slide 4

11.6 SPECIAL CONSIDERATIONS

☐ TPSs can be dedicated for special techniques (requiring a **dedicated TPS**) that require careful consideration, owing to their inherent complexity.

- Brachytherapy
- Stereotactic radiosurgery
- Orthovoltage radiotherapy
- Tomotherapy
- IMRT
- Intraoperative radiotherapy
- Dynamic MLC
- D shaped beams for choroidal melanoma
- Total body irradiation (TBI)
- Electron beam arc therapy
- Micro MLC
- Total skin electron irradiation

